

LMV751

Low Noise, Low Vos, Single Op Amp

General Description

The LMV751 is a high performance CMOS operational amplifier intended for applications requiring low noise and low input offset voltage. It offers modest bandwidth of 4.5MHz for very low supply current and is unity gain stable.

The output stage is able to drive high capacitance, up to 1000pF and source or sink 8mA output current.

It is supplied in the space saving SOT23-5 Tiny package.

The LMV751 is designed to meet the demands of small size, low power, and high performance required by cellular phones and similar battery operated portable electronics.

Features

- Low noise $6.5\text{nV}/\sqrt{\text{Hz}}$
- Low V_{OS} (0.05mV typ.)
- Wideband 4.5MHz GBP typ.
- Low supply current 500uA typ.
- Low supply voltage 2.7V to 5.0V
- Ground-referenced inputs
- Unity gain stable
- Small Package

Applications

- Cellular phones
- Portable equipment
- Radio systems

Connection Diagram

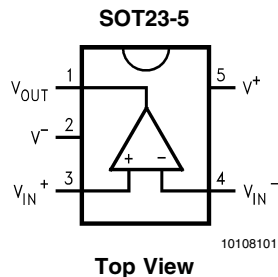

Ordering Information

Package	Part Number	Package Marking	Transport Media	NSC Drawing
5-Pin SOT23-5	LMV751M5	A32A	1k Units Tape and Reel	MA05B
	LMV751M5X		3k units Tape and Reel	

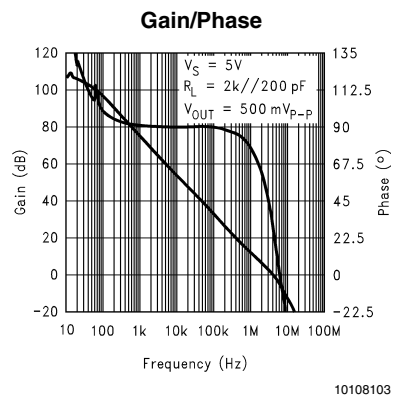
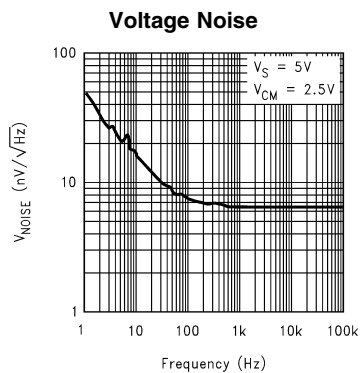

Absolute Maximum Ratings (Note 1)Junction Temperature (T_J) (Note 4)

150°C

If Military/Aerospace specified devices are required, please contact the National Semiconductor Sales Office/Distributors for availability and specifications.

ESD Tolerance (Note 3)

Human Body Model 2000V

Machine Model 200V

Differential Input Voltage \pm Supply VoltageSupply Voltage ($V^+ - V^-$) 5.5V

Lead Temperature (Soldering, 10 sec.) 260°C

Storage Temperature Range -65°C to 150°C

Recommended Operating Conditions

Supply Voltage 2.7V to 5.0V

Temperature Range $-40^\circ\text{C} \leq T_J \leq 85^\circ\text{C}$ Thermal Resistance (θ_{JA}) (Note 6)

M5 Package, SOT23-5 274°C/W

2.7V Electrical Characteristics

$V^+ = 2.7\text{V}$, $V^- = 0\text{V}$, $V_{CM} = 1.35\text{V}$, $T_A = 25^\circ\text{C}$ unless otherwise stated. **Boldface limits** apply over the Temperature Range.

Symbol	Parameter	Condition	Typ (Note 5)	Limit (Note 2)	Units
V_{OS}	Input Offset Voltage		0.05	1.0 1.5	mV max
V_{CM}	Input common-Mode Voltage Range	For CMRR \geq 50dB		0	V min
			1.4	1.3	V max
CMRR	Common Mode Rejection Ratio	$0\text{V} < V_{CM} < 1.3\text{V}$	100	85 70	dB min
PSRR	Power Supply Rejection Ratio	$V^+ = 2.7\text{V}$ to 5.0V	107	85 70	dB min
I_S	Supply Current		0.5	0.8 0.85	mA max
I_{IN}	Input Current		1.5	100	pA max
I_{OS}	Input Offset Current		0.2		pA
A_{VOL}	Voltage Gain	$R_L = 10\text{k}$ Connect to $V^+/2$ $V_O = 0.2\text{V}$ to 2.2V	120	110 95	dB min
		$R_L = 2\text{k}$ Connect to $V^+/2$ $V_O = 0.2\text{V}$ to 2.2V	120	100 85	
V_O	Positive Voltage Swing	$R_L = 10\text{k}$ Connect to $V^+/2$	2.62	2.54 2.52	V min
		$R_L = 2\text{k}$ Connect to $V^+/2$	2.62	2.54 2.52	
V_O	Negative Voltage Swing	$R_L = 10\text{k}$ Connect to $V^+/2$	78	140 160	mV max
		$R_L = 2\text{k}$ Connect to $V^+/2$	78	160 180	
I_O	Output Current	Sourcing, $V_O = 0\text{V}$ V_{IN} (diff) = $\pm 0.5\text{V}$	12	6.0 1.5	mA min
		Sinking, $V_O = 2.7\text{V}$ V_{IN} (diff) = $\pm 0.5\text{V}$	11	6.0 1.5	
e_n (10Hz)	Input Referred Voltage Noise		15.5		nV/ $\sqrt{\text{Hz}}$
e_n (1kHz)	Input Referred Voltage Noise		7		nV/ $\sqrt{\text{Hz}}$

2.7V Electrical Characteristics (Continued)

$V^+ = 2.7V$, $V^- = 0V$, $V_{CM} = 1.35V$, $T_A = 25^\circ C$ unless otherwise stated. **Boldface limits** apply over the Temperature Range.

Symbol	Parameter	Condition	Typ (Note 5)	Limit (Note 2)	Units
e_n (30kHz)	Input Referred Voltage Noise		7	10	nV/\sqrt{Hz} max
I_N (1kHz)	Input Referred Current Noise		0.01		pA/\sqrt{Hz}
GBW	Gain-Bandwidth Product		4.5	2	MHZ min
SR	Slew Rate		2		$V/\mu s$

5.0V Electrical Characteristics

$V^+ = 5.0V$, $V^- = 0V$, $V_{CM} = 2.5V$, $T_A = 25^\circ C$ unless otherwise stated. **Boldface limits** apply over the Temperature Range.

Symbol	Parameter	Condition	Typ (Note 5)	Limit (Note 2)	Units
V_{OS}	Input Offset Voltage		0.05	1.0 1.5	mV max
CMRR	Common Mode Rejection Ratio	$0V < V_{CM} < 3.6V$	103	85 70	dB min
V_{CM}	Input Common-Mode Voltage Range	For CMRR $\geq 50dB$		0	V min
			3.7	3.6	V max
PSRR	Power Supply Rejection Ratio	$V^+ = 2.7V$ to $5.0V$	107	85 70	dB min
I_S	Supply Current		0.6	0.9 0.95	mA max
I_{IN}	Input Current		1.5	100	pA max
I_{OS}	Input offset Current		0.2		pA
A_{VOL}	Voltage Gain	$R_L = 10k$ Connect to $V^+/2$ $V_O = 0.2V$ to $4.5V$	120	110 95	db min
		$R_L = 2k$ Connect to $V^+/2$ $V_O = 0.2V$ to $4.5V$	120	100 85	
V_O	Positive Voltage Swing	$R_L = 10k$ Connect to $V^+/2$	4.89	4.82 4.80	V min
		$R_L = 2k$ Connect to $V^+/2$	4.89	4.82 4.80	
V_O	Negative Voltage Swing	$R_L = 10k$ Connect to $V^+/2$	86	160 180	mV max
		$R_L = 2k$ Connect to $V^+/2$	86	180 200	
I_O	Output Current	Sourcing, $V_O = 0V$ V_{IN} (diff) = $\pm 0.5V$	15	8.0 2.5	mA min
		Sinking, $V_O = 5V$ V_{IN} (diff) = $\pm 0.5V$	20	8.0 2.5	
e_n (10Hz)	Input Referred Voltage Noise		15		nV/\sqrt{Hz}
e_n (1kHz)	Input Referred Voltage Noise		6.5		nV/\sqrt{Hz}

5.0V Electrical Characteristics (Continued)

$V^+ = 5.0V$, $V^- = 0V$, $V_{CM} = 2.5V$, $T_A = 25^\circ C$ unless otherwise stated. **Boldface limits** apply over the Temperature Range.

Symbol	Parameter		Typ (Note 5)	Limit (Note 2)	Units
e_n (30kHz)	Input Referred Voltage Noise		6.5	10	nV/ \sqrt{Hz} max
I_N (1kHz)	Input Referred Current Noise		0.01		pA/ \sqrt{Hz}
GBW	Gain-Bandwidth Product		5	2	MHz min
SR	Slew Rate		2.3		V/ μ s

Note 1: Absolute Maximum Ratings indicate limits beyond which damage to the device may occur. Electrical specifications do not apply when operating the device beyond its rated operating conditions.

Note 2: All limits are guaranteed by testing or statistical analysis

Note 3: Human body model, 1.5k Ω in series with 100pF. Machine model, 200 Ω in series with 1000pF.

Note 4: The maximum power dissipation is a function of $T_{J(MAX)}$, θ_{JA} , and T_A . The maximum allowable power dissipation at any ambient temperature is $P_D = (T_{J(MAX)} - T_A)/\theta_{JA}$. All numbers apply for packages soldered directly into a PC board.

Note 5: Typical values represent the most likely parametric norm.

Note 6: All numbers are typical, and apply to packages soldered directly onto PC board in still air.

Typical Performance Characteristics

Supply Current vs. Voltage

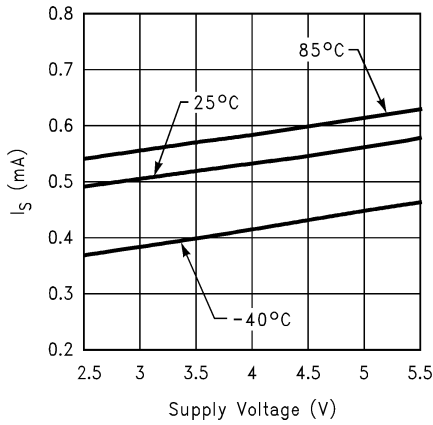

10108135

V_{OS} vs. V_{CM} , $V^+ = 2.7V$

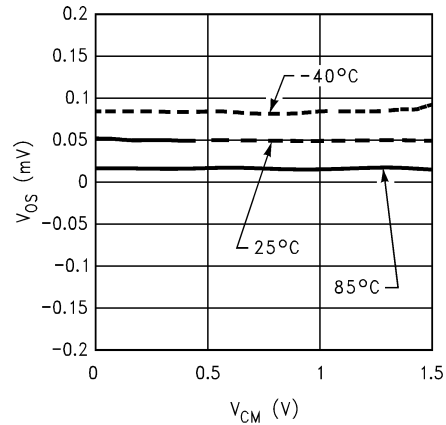

10108138

V_{OS} vs. V_{CM} , $V^+ = 5.0V$

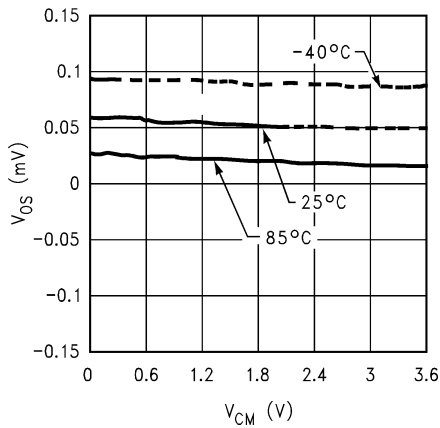

10108137

Source Current vs. Out, $V^+ = 2.7V$

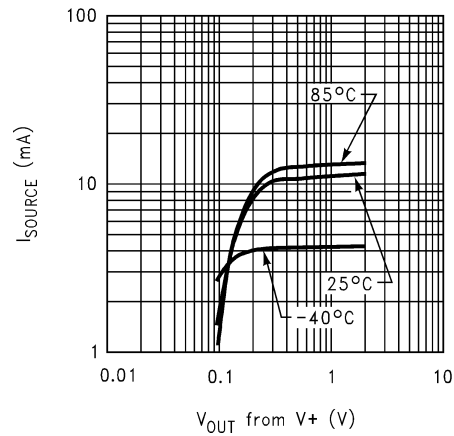

10108128

Source Current vs. V_{OUT} , $V^+ = 5.0V$

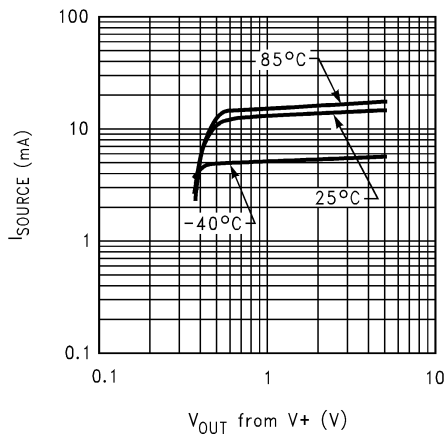

10108129

Gain/Phase

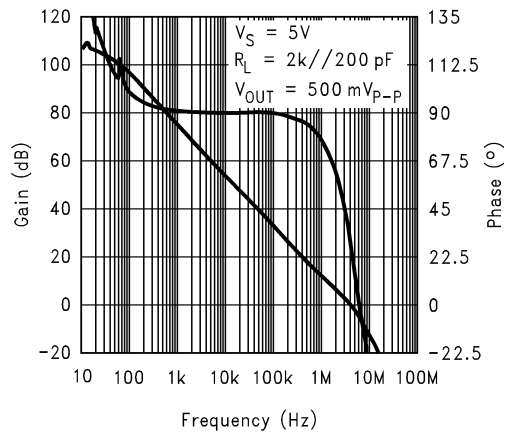

10108103

Typical Performance Characteristics (Continued)

Sinking Current vs. V_{OUT} , $V^+ = 2.7V$

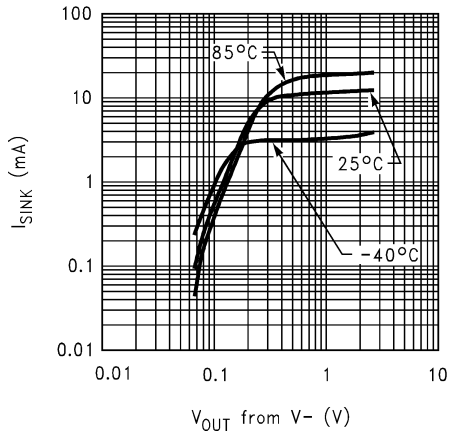

10108130

Sinking Current vs. V_{OUT} , $V^+ = 5.0V$

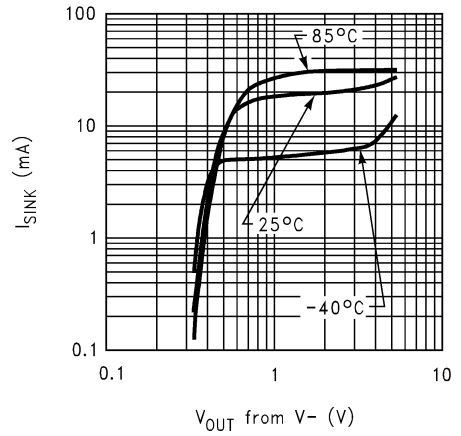

10108131

V_{OS} vs. V^+

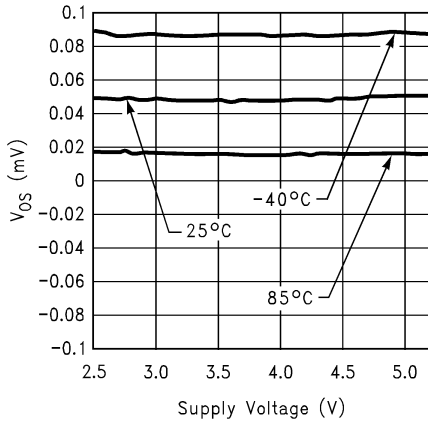

10108136

V_{IN} vs. V_{OUT} , $V^+ = 2.7V$, $R_L = 2k$

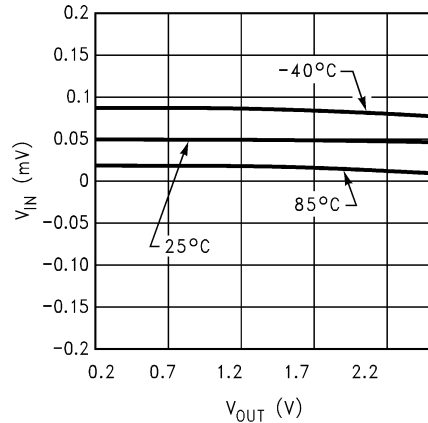

10108132

V_{IN} vs. V_{OUT} , $V^+ = 5.0V$, $R_L = 2k$

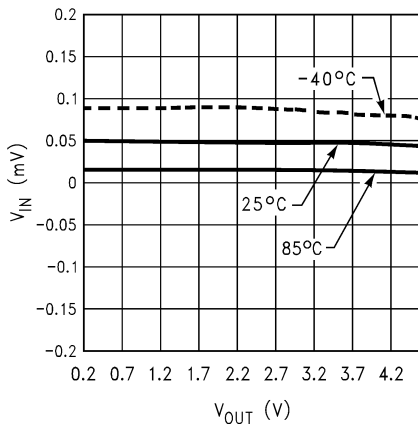

10108133

Input Bias vs. V_{CM} , $T_A = 25^\circ C$

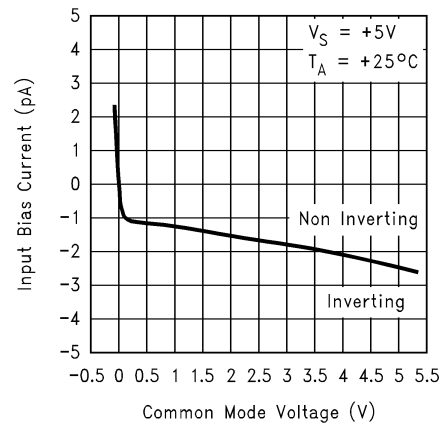

10108116

Typical Performance Characteristics (Continued)

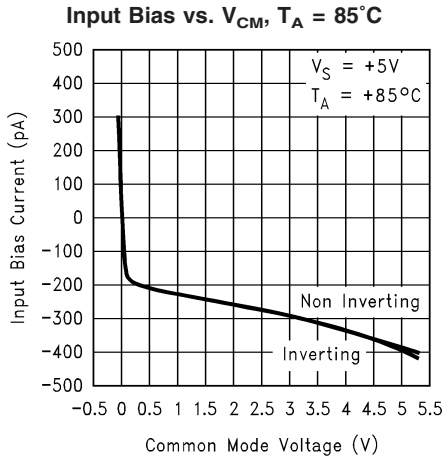

10108105

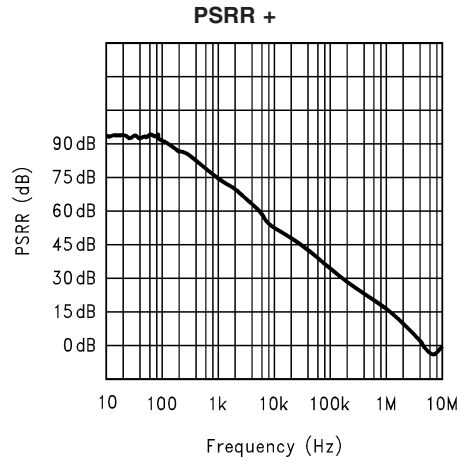

10108126

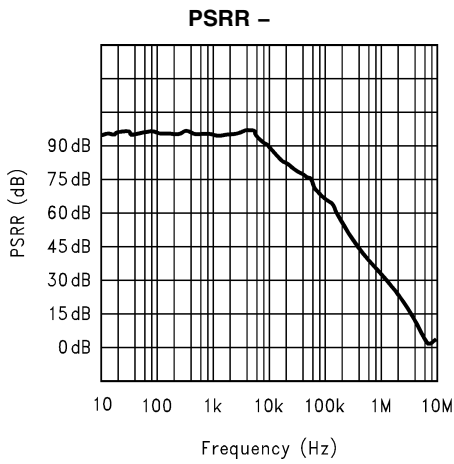

10108125

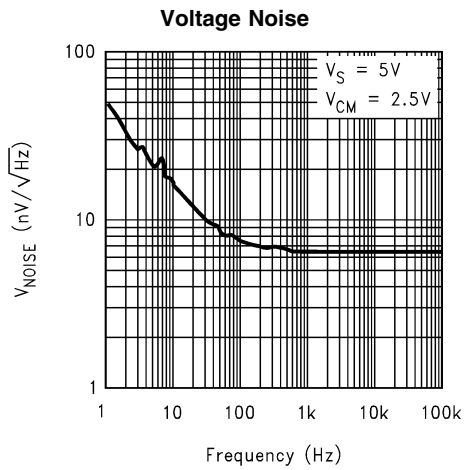

10108102

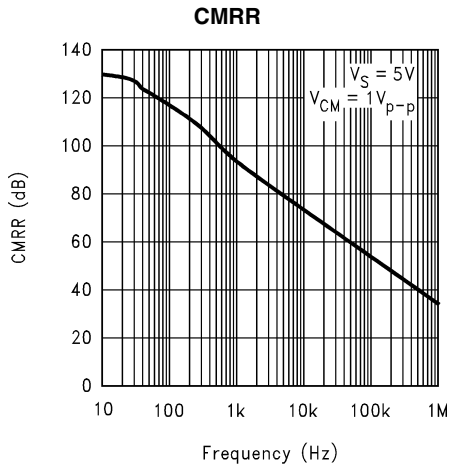

10108139

Application Hints

1.0 Noise

There are many sources of noise in a system: thermal noise, shot noise, $1/f$, popcorn noise, resistor noise, just to name a few. In addition to starting with a low noise op amp, such as the LMV751, careful attention to detail will result in the lowest overall noise for the system.

1.1 To invert or not invert?

Both inverting and non-inverting amplifiers employ feedback to stabilize the closed loop gain of the block being designed. The loop gain (in decibels) equals the algebraic difference between the open loop and closed loop gains. Feedback improves the Total Harmonic Distortion (THD) and the output impedance. The various noise sources, when input referred, are amplified, not by the closed loop gain, but by the noise gain. For a non-inverting amplifier, the noise gain is equal to the closed loop gain, but for an inverting amplifier, the noise gain is equal to the closed loop gain plus one. For large gains, e.g., 100, the difference is negligible, but for small gains, such as one, the noise gain for the inverting amplifier would be two. This implies that non-inverting blocks are preferred at low gains.

1.2 Source impedance

Because noise sources are uncorrelated, the system noise is calculated by taking the RMS sum of the various noise sources, that is, the square root of the sum of the squares. At very low source impedances, the voltage noise will dominate; at very high source impedances, the input noise current times the equivalent external resistance will dominate. For a detailed example calculation, refer to Note 1.

1.3 Bias current compensation resistor

In CMOS input op amps, the input bias currents are very low, so there is no need to use R_{COMP} (Figure 1 and 2) for bias current compensation that would normally be used with early generation bipolar op amps. In fact, inclusion of the resistor would act as another thermal noise source in the system, increasing the overall noise.

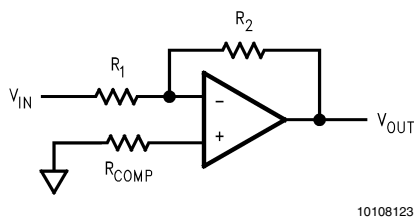

10108123

FIGURE 1.

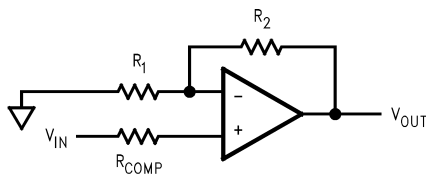

10108124

FIGURE 2.

1.4 Resistor types

Thermal noise is generated by any passive resistive element. This noise is 'white'; meaning it has a constant spectral density. Thermal noise can be represented by a mean-square voltage generator e_R^2 in series with a noiseless resistor, where e_R^2 is given by: Where:

$$e_R^2 = 4K TRB \text{ (volts)}^2$$

Where T = temperature in °K

R = resistor value in ohms

B = noise bandwidth in Hz

K = Boltzmann's constant (1.38×10^{-23} W-sec/°K)

Actual resistor noise measurements may have more noise than the calculated value. This additional noise component is known as excess noise. Excess noise has a $1/f$ spectral response, and is proportional to the voltage drop across the resistor. It is convenient to define a noise index when referring to excess noise in resistors. The noise index is the RMS value in μV of noise in the resistor per volt of DC drop across the resistor in a decade of frequency. Noise index expressed in dB is:

$$NI = 20 \log ((E_{EX}/V_{DC}) \times 10^6) \text{ db}$$

Where: E_{EX} = resistor excess noise in μV per frequency decade.

V_{DC} = DC voltage drop across the resistor.

Excess noise in carbon composition resistors corresponds to a large noise index of +10 dB to -20 dB. Carbon film resistors have a noise index of -10 dB to -25 dB. Metal film and wire wound resistors show the least amount of excess noise, with a noise index figure of -15 dB to -40 dB.

1.5 Other noise sources:

As the op amp and resistor noise sources are decreased, other noise contributors will now be noticeable. Small air currents across thermocouples will result in low frequency variations. Any two dissimilar metals, such as the lead on the IC and the solder and copper foil of the pc board, will form a thermocouple. The source itself may also generate noise. An example would be a resistive bridge. All resistive sources generate thermal noise based on the same equation listed above under 'resistor types'.(2)

1.6 Putting it all together

To a first approximation, the total input referred noise of an op amp is:

$$E_t^2 = e_n^2 + e_{req}^2 + (i_n * Req)^2$$

where Req is the equivalent source resistance at the inputs. At low impedances, voltage noise dominates. At high impedances, current noise dominates. With a typical noise current on most CMOS input op amps of $0.01 \text{ pA}/\sqrt{\text{Hz}}$, the current noise contribution will be smaller than the voltage noise for Req less than one megohm.

2.0 Other Considerations

2.1 Comparator operation

Occasionally operational amplifiers are used as comparators. This is not optimum for the LMV751 for several reasons. First, the LMV751 is compensated for unity gain stability, so the speed will be less than could be obtained on the same process with a circuit specifically designed for comparator operation. Second, op amp output stages are designed to be linear, and will not necessarily meet the logic levels required under all conditions. Lastly, the LMV751 has the newer PNP-NPN common emitter output stage, characteristic of many rail-to-rail output op amps. This means that

Application Hints (Continued)

when used in open loop applications, such as comparators, with very light loads, the output PNP will saturate, with the output current being diverted into the previous stage. As a result, the supply current will increase to the 20-30 mA range. When used as a comparator, a resistive load between 2k Ω and 10k Ω should be used with a small amount of hysteresis to alleviate this problem. When used as an op amp, the closed loop gain will drive the inverting input to within a few millivolts of the non-inverting input. This will automatically reduce the output drive as the output settles to the correct value; thus it is only when used as a comparator that the current will increase to the tens of milliampere range.

2.2 Rail-to-Rail

Because of the output stage discussed above, the LMV751 will swing "rail-to-rail" on the output. This normally means within a few hundred millivolts of each rail with a reasonable load. Referring to the Electrical Characteristics table for 2.7V to 5.0V, it can be seen that this is true for resistive loads of 2k Ω and 10k Ω . The input stage consists of cascoded P-channel MOSFETS, so the input common mode range includes ground, but typically requires 1.2V to 1.3V head-

room from the positive rail. This is better than the industry standard LM324 and LM358 that have PNP input stages, and the LMV751 has the advantage of much lower input bias currents.

2.3 Loading

The LMV751 is a low noise, high speed op amp with excellent phase margin and stability. Capacitive loads up to 1000 pF can be handled, but larger capacitive loads should be isolated from the output. The most straightforward way to do this is to put a resistor in series with the output. This resistor will also prevent excess power dissipation if the output is accidentally shorted.

2.4 General Circuits

With the low noise and low input bias current, the LMV751 would be useful in active filters, integrators, current to voltage converters, low frequency sine wave generators, and instrumentation amplifiers. (3)

- Note:**
1. Sherwin, Jim "Noise Specs Confusing?" AN-104, National Semiconductor.
 2. Christensen, John, "Noise-figure curve ease the selection of low-noise op amps", EDN, pp 81-84, Aug. 4, 1994
 3. "Op Amp Circuit Collection", AN-31, National Semiconductor.

Physical Dimensions inches (millimeters)

unless otherwise noted

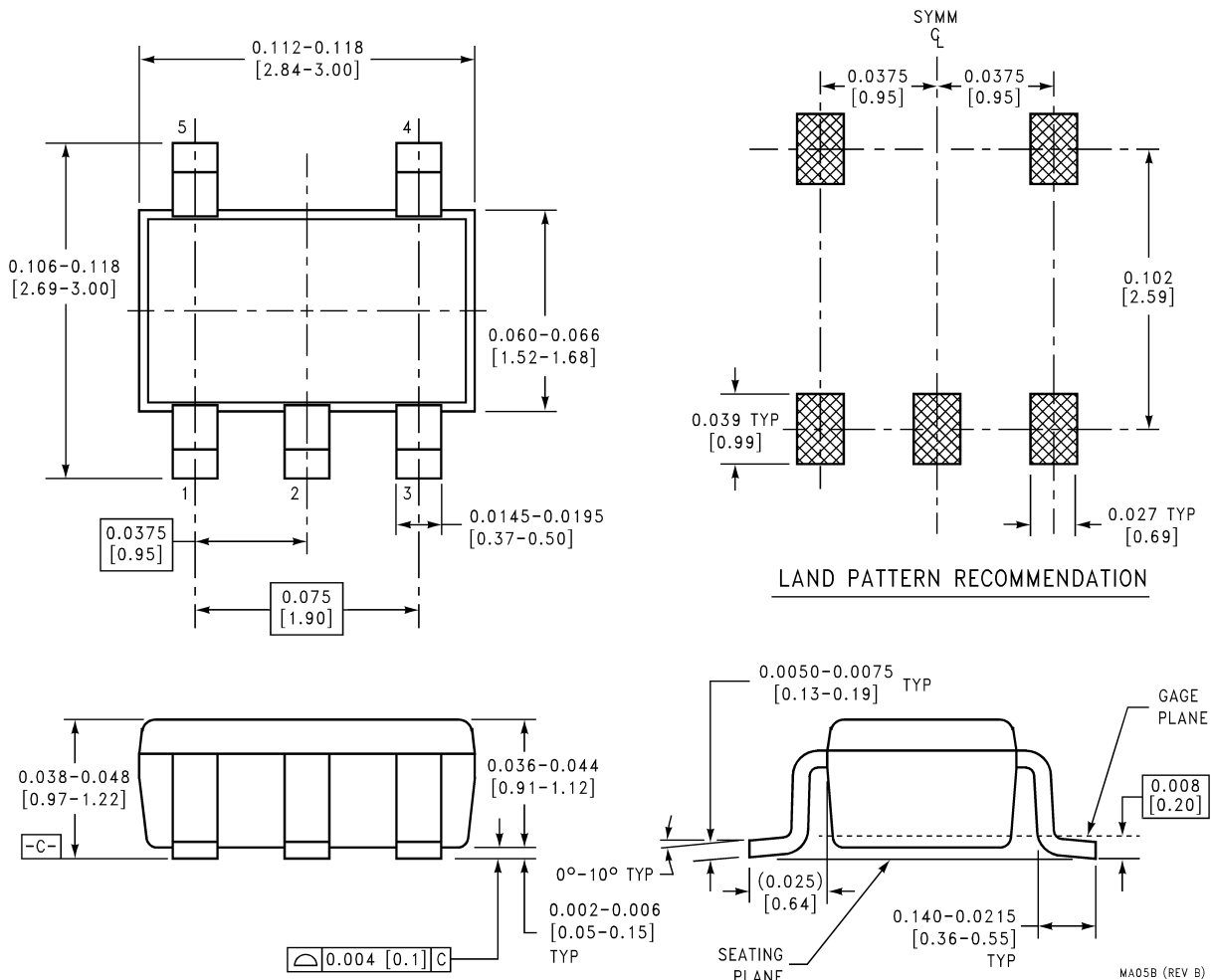

SOT23-5
NS Package Number MA05B

LIFE SUPPORT POLICY

NATIONAL'S PRODUCTS ARE NOT AUTHORIZED FOR USE AS CRITICAL COMPONENTS IN LIFE SUPPORT DEVICES OR SYSTEMS WITHOUT THE EXPRESS WRITTEN APPROVAL OF THE PRESIDENT AND GENERAL COUNSEL OF NATIONAL SEMICONDUCTOR CORPORATION. As used herein:

1. Life support devices or systems are devices or systems which, (a) are intended for surgical implant into the body, or (b) support or sustain life, and whose failure to perform when properly used in accordance with instructions for use provided in the labeling, can be reasonably expected to result in a significant injury to the user.
2. A critical component is any component of a life support device or system whose failure to perform can be reasonably expected to cause the failure of the life support device or system, or to affect its safety or effectiveness.



National Semiconductor Corporation
Americas
Email: support@nsc.com

www.national.com

National Semiconductor Europe
Fax: +49 (0) 180-530 85 86
Email: europe.support@nsc.com
Deutsch Tel: +49 (0) 69 9508 6208
English Tel: +44 (0) 870 24 0 2171
Français Tel: +33 (0) 1 41 91 8790

National Semiconductor Asia Pacific Customer Response Group
Tel: 65-2544466
Fax: 65-2504466
Email: ap.support@nsc.com

National Semiconductor Japan Ltd.
Tel: 81-3-5639-7560
Fax: 81-3-5639-7507